

# ARBORFORM Panels Order/Quote Form

Phone: 07 847 8217, Email: sales@arborline.co.nz, Free fax: 0508 478 221



Customer: \_\_\_\_\_ Order No: \_\_\_\_\_

Delivery: \_\_\_\_\_ Date: \_\_\_\_\_

Phone: \_\_\_\_\_ Required By: \_\_\_\_\_

Style: \_\_\_\_\_ Colour: \_\_\_\_\_

Contact: \_\_\_\_\_ Email: \_\_\_\_\_

- Embossed     Gloss     Satin  
 Woodgrain     Super Matt

Note: All gloss panels will be R1

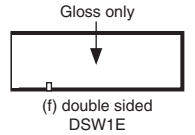
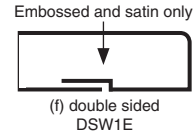
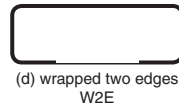
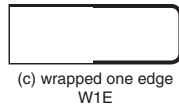
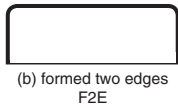
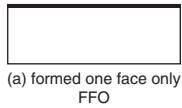

QTY	HEIGHT	WIDTH	TOP	BOT	LH	RH	DESCRIPTION
-----	--------	-------	-----	-----	----	----	-------------

The following are **Formed panels only**, e.g. FFO, F1E, F2E, F3E & F4E

1							
2							
3							
4							
5							
6							
7							
8							
9							
10							
11							
12							

The following are **Wrapped panels only**, e.g. W1E & W2E

13							
14							
15							
16							
17							
18							
19							
20							
21							
22							
23							
24							

The following are **Double sided and special panels only**, e.g. DS1E & DSW1E

25							
26							
27							
28							
29							

# ARBORLINE GLOSS PANEL PROFILES

## Wrapped one edge W1E

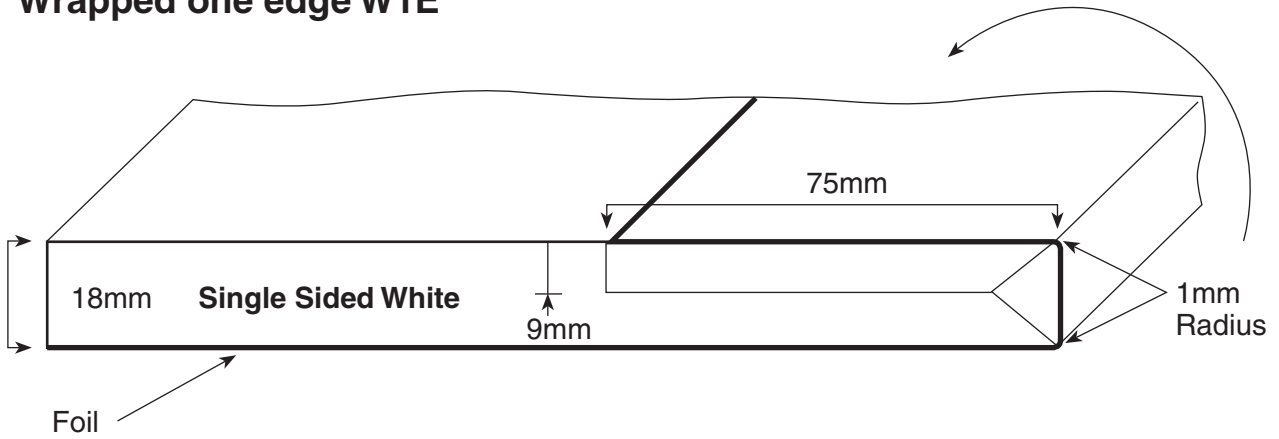

## DOUBLE Sided Formed one edge DSF1E

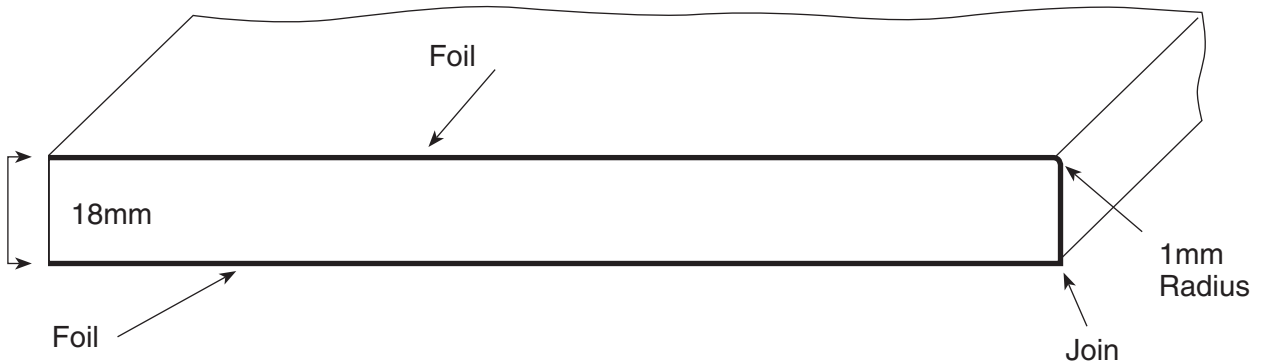

Drawings not to scale

## ORDERING EXAMPLE

	QTY	HEIGHT	WIDTH	TOP	BOT	LH	RH	DESCRIPTION
1	1	2400	480					FFO
2	1	2390	700				R3	F1E
3	1	700	420			R3	R3	F2E
4	1	1012	350			R3		W1E
5	1	990	300	✓		R3	R3	W2E - CLASH TOP
6	1	2390	720	✓	✓		R3	DSW1E - CLASH TOP & BOT
7	1	2400	710				R1	DSF1E